

Article number: 439600095

Description: Rota-fix shaft-hub connection FS95x135

Note: Self centering - very high torque.

## Measures

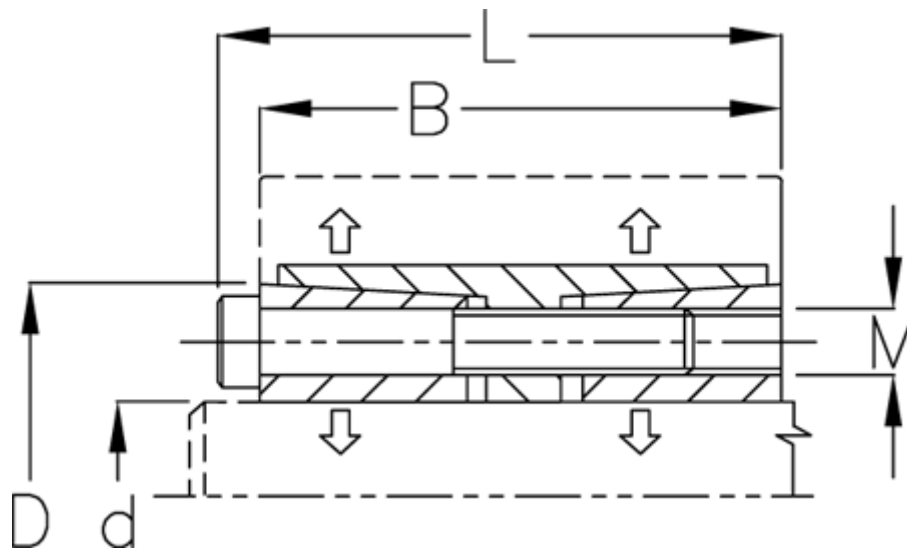

B mm	= 62
d H8 mm	= 95
D mm	= 135
Fit tolerance	= Aksel h8, Nav H8
F kN torque	= 284.0
L mm	= 72
M mm	= M10
P N/mm <sup>2</sup> surface pressure on shaft/hub	= 140

Surface roughness	= R? ? 3.2 µm
T N m torque	= 13500
Ts N m bolt tightening torque	= 83.0